



# SoftSlide

## Wardrobe sliding door system



Maximum door panel weight of 80kg.



Featuring high quality components



Full technical support



Quick and easy to install



Height adjustment up to 6mm



Includes soft close

The SoftSlide features a maximum door capacity of 80kg, easy to install and the height can be adjusted by 6mm for a custom fit. Its integral bearings offer smooth and quiet operation, while the soft-close option ensures a controlled closure.

SoftSlide is designed for quick and easy installation, making it a hassle-free solution.

### SoftSlide Components

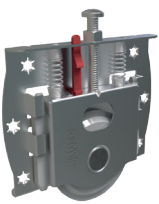

Bottom rollers

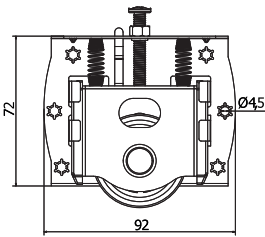

Top guides

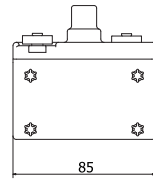

Min 32 / Max 40



Sprung loaded top guide



Soft close unit

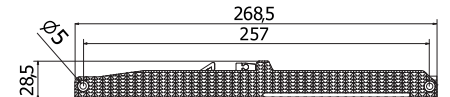

Fitting kit for two door includes: 4 x top guides, 4 x bottom rollers and 1 x soft close unit

3 Metre top track

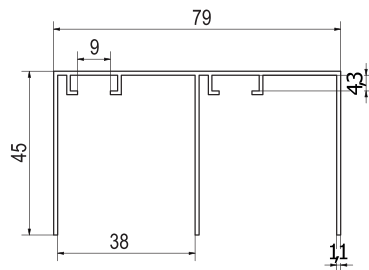

Recess Fix

3 Metre bottom rail

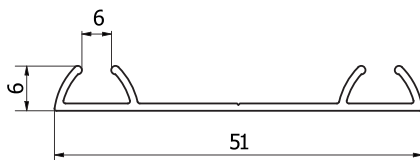

Description	Code
SoftSlide Kit 2 Door, 3m Track	SS3000-2
SoftSlide Kit 4 Door, 3m Track	SS3000-4
SoftSlide Kit 2 Door, 6m (2 x3M) Track	SS6000-2
SoftSlide Kit 4 Door, 6m (2 x3M) Track	SS6000-4



## Specification

- Maximum door panel weight: 80kg
- Minimum door thickness: 16mm
- Maximum door thickness: 24mm
- Up and Down Adjustment Option: Up to 6 mm



$y = 86$

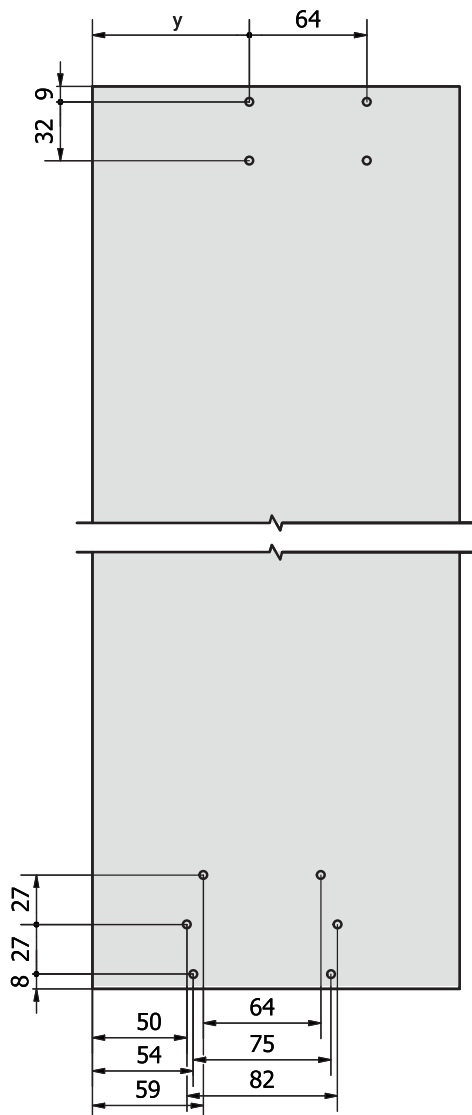

$y = L - 52$

